

Infinite System Specification

— Square series



S-CS3535D

S-CS5035D

S-CS7035D

S-CS3535P

S-CS5035P

S-CS7035P

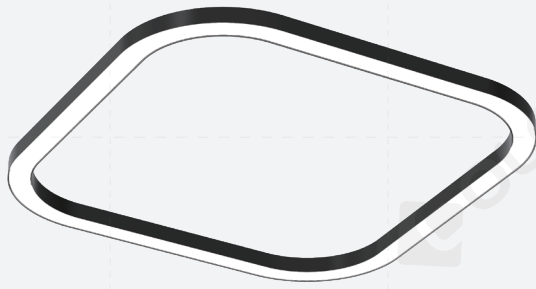

Optical: Diffuser

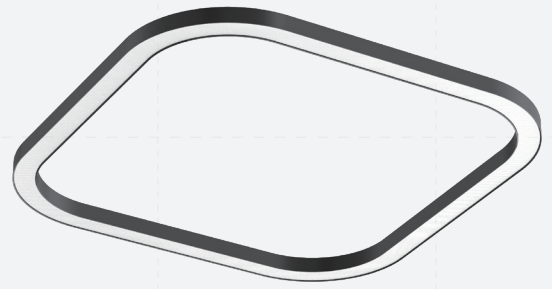

Optical: Prismatic

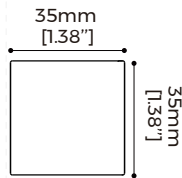

Model:
S-CS3535D
S-CS3535P

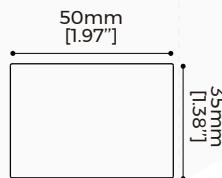

Model:
S-CS5035D
S-CS5035P

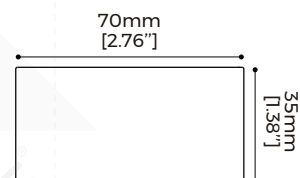

Model:
S-CS7035D
S-CS7035P

Basic Information

Light efficiency

S-CS3535D 100LM/W(Regular), 120LM/W(High-Efficiency)	S-CS3535P 85LM/W(Regular), 105LM/W(High-Efficiency)
S-CS5035D 100LM/W(Regular), 120LM/W(High-Efficiency)	S-CS5035P 90LM/W(Regular), 105LM/W(High-Efficiency)
S-CS7035D 110LM/W(Regular), 135LM/W(High-Efficiency)	S-CS7035P 100LM/W(Regular), 120LM/W(High-Efficiency)

Side length

S-CS3535D/S-CS3535P/S-CS5035D/S-CS5035P 600/900/1200/1500/1800/2400mm	S-CS7035D/S-CS7035P 900/1200/1500/1800/2400mm
---	---

Common information

- Material: AL6063-T5, spraying surface
- Color: Black/White/Silver/Orange/Blue/Green /Rose gold/Champagne gold
- IP grade: IP20
- CCT: 2700/3000/3500/4000/5000/6500K
- CRI: >80/>90
- SDCM: ≤3 Step
- Dimming method: Non-dimming, 1-10V, DALI2+PUSH
- Application: Indoor
- Installation: Ceiling/Pendant
- Certification: CE, UKCA, ROHS, REACH, CB, ENEC, ETL, LM-80
- Warranty: 5 years

© Product Dimension Information

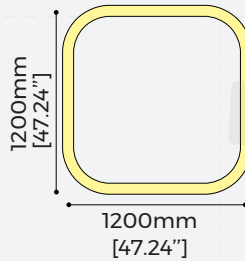
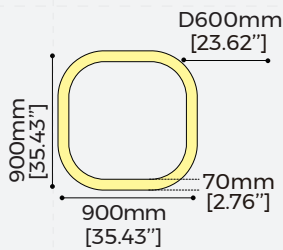
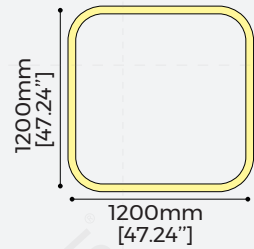
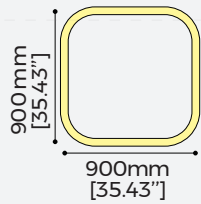
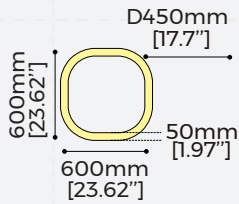
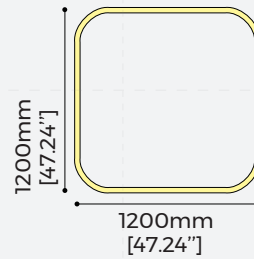
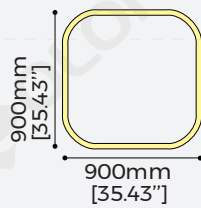
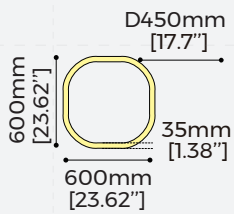

Case 1: For length of sides $\leq 1.2\text{m}$, the lamp is to be produced as complete unit.

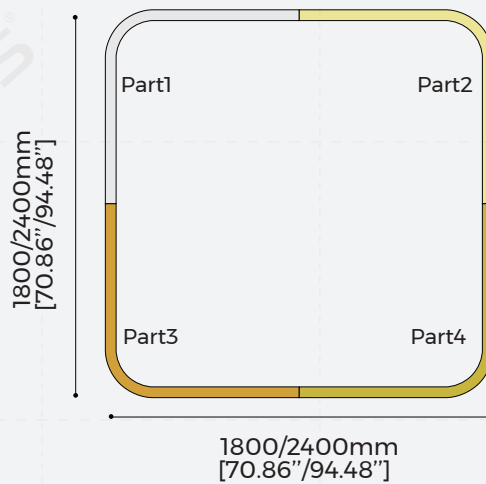
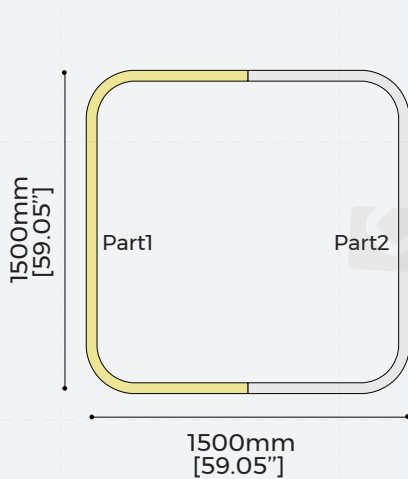

Case 2: For length of side $> 1.2\text{m}$, the lamp is to be divided into parts

© Luminaire Parameters

Model	Version	Length (mm)	Type Power (W/PCS)	Input Voltage (V)	Input Current (mA)	CRI	Lumens (LM/PCS)	CCT
S-CS3535D	Regular	600 [1.97ft]	36	AC200-240V	180	>80	3600	2700K 3000K 3500K 4000K 5000K 6500K
						>90	3096	
		900 [2.95ft]	60	AC200-240V	300	>80	6000	
						>90	5160	
		1200 [3.94ft]	78	AC200-240V	390	>80	7800	
						>90	6708	
		1500 [4.92ft]	108	AC200-240V	550	>80	10800	
						>90	9288	
		1800 [5.91ft]	128	AC200-240V	650	>80	12800	
						>90	11008	
		2400 [7.87ft]	156	AC200-240V	790	>80	15600	
						>90	13416	
	High-Efficiency	600 [1.97ft]	36	AC200-240V	180	>80	4320	
						>90	3715	
		900 [2.95ft]	60	AC200-240V	300	>80	7200	
						>90	6192	
		1200 [3.94ft]	78	AC200-240V	390	>80	9360	
						>90	8050	
		1500 [4.92ft]	108	AC200-240V	550	>80	12960	
						>90	11146	
		1800 [5.91ft]	128	AC200-240V	650	>80	15360	
						>90	13210	
		2400 [7.87ft]	156	AC200-240V	790	>80	18720	
						>90	16099	

Model	Version	Length (mm)	Type Power (W/PCS)	Input Voltage (V)	Input Current (mA)	CRI	Lumens (LM/PCS)	CCT
S-CS3535P	Regular	600 [1.97ft]	36	AC200-240V	180	>80	3060	2700K 3000K 3500K 4000K 5000K 6500K
						>90	2632	
		900 [2.95ft]	60	AC200-240V	300	>80	5100	
						>90	4386	
		1200 [3.94ft]	78	AC200-240V	390	>80	6630	
						>90	5702	
		1500 [4.92ft]	108	AC200-240V	550	>80	9180	
						>90	7895	
		1800 [5.91ft]	128	AC200-240V	650	>80	10880	
						>90	9357	
		2400 [7.87ft]	156	AC200-240V	790	>80	13260	
						>90	11404	
	High-Efficiency	600 [1.97ft]	36	AC200-240V	180	>80	3780	
						>90	3251	
		900 [2.95ft]	60	AC200-240V	300	>80	6300	
						>90	5418	
		1200 [3.94ft]	78	AC200-240V	390	>80	8190	
						>90	7043	
		1500 [4.92ft]	108	AC200-240V	550	>80	11340	
						>90	9752	
		1800 [5.91ft]	128	AC200-240V	650	>80	13440	
						>90	11558	
		2400 [7.87ft]	156	AC200-240V	790	>80	16380	
						>90	14087	

Model	Version	Length (mm)	Type Power (W/PCS)	Input Voltage (V)	Input Current (mA)	CRI	Lumens (LM/PCS)	CCT
S-CS5035D	Regular	600 [1.97ft]	44	AC200-240V	220	>80	4400	2700K 3000K 3500K 4000K 5000K 6500K
						>90	3784	
		900 [2.95ft]	75	AC200-240V	380	>80	7500	
						>90	6450	
		1200 [3.94ft]	104	AC200-240V	530	>80	10400	
						>90	8944	
		1500 [4.92ft]	135	AC200-240V	680	>80	13500	
						>90	11610	
		1800 [5.91ft]	156	AC200-240V	790	>80	15600	
						>90	13416	
		2400 [7.87ft]	224	AC200-240V	1130	>80	22400	
						>90	19264	
	High-Efficiency	600 [1.97ft]	44	AC200-240V	220	>80	5280	
						>90	4541	
		900 [2.95ft]	75	AC200-240V	380	>80	9000	
						>90	7740	
		1200 [3.94ft]	104	AC200-240V	530	>80	12480	
						>90	10733	
		1500 [4.92ft]	135	AC200-240V	680	>80	16200	
						>90	13932	
		1800 [5.91ft]	156	AC200-240V	790	>80	18720	
						>90	16099	
		2400 [7.87ft]	224	AC200-240V	1130	>80	26880	
						>90	23117	

Model	Version	Length (mm)	Type Power (W/PCS)	Input Voltage (V)	Input Current (mA)	CRI	Lumens (LM/PCS)	CCT
S-CS5035P	Regular	600 [1.97ft]	44	AC200-240V	220	>80	3960	2700K 3000K 3500K 4000K 5000K 6500K
						>90	3406	
		900 [2.95ft]	75	AC200-240V	380	>80	6750	
						>90	5805	
		1200 [3.94ft]	104	AC200-240V	530	>80	9360	
						>90	8050	
		1500 [4.92ft]	135	AC200-240V	680	>80	12150	
						>90	10449	
		1800 [5.91ft]	156	AC200-240V	790	>80	14040	
						>90	12074	
		2400 [7.87ft]	224	AC200-240V	1130	>80	20160	
						>90	17338	
	High-Efficiency	600 [1.97ft]	44	AC200-240V	220	>80	4620	
						>90	3973	
		900 [2.95ft]	75	AC200-240V	380	>80	7875	
						>90	6773	
		1200 [3.94ft]	104	AC200-240V	530	>80	10920	
						>90	9391	
		1500 [4.92ft]	135	AC200-240V	680	>80	14175	
						>90	12191	
		1800 [5.91ft]	156	AC200-240V	790	>80	16380	
						>90	14087	
		2400 [7.87ft]	224	AC200-240V	1130	>80	23520	
						>90	20227	

Model	Version	Length (mm)	Type Power (W/PCS)	Input Voltage (V)	Input Current (mA)	CRI	Lumens (LM/PCS)	CCT
S-CS7035D	Regular	900 [2.95ft]	96	AC200-240V	480	>80	10560	2700K 3000K 3500K 4000K 5000K 6500K
						>90	9082	
		1200 [3.94ft]	136	AC200-240V	690	>80	14960	
						>90	12866	
		1500 [4.92ft]	156	AC200-240V	790	>80	17160	
						>90	14758	
		1800 [5.91ft]	216	AC200-240V	1090	>80	23760	
						>90	20434	
		2400 [7.87ft]	300	AC200-240V	1520	>80	33000	
						>90	28380	
	High-Efficiency	900 [2.95ft]	96	AC200-240V	480	>80	12960	
						>90	11146	
		1200 [3.94ft]	136	AC200-240V	690	>80	18360	
						>90	15790	
1500 [4.92ft]		156	AC200-240V	790	>80	21060		
					>90	18112		
1800 [5.91ft]	216	AC200-240V	1090	>80	29160			
				>90	25078			
2400 [7.87ft]	300	AC200-240V	1520	>80	40500			
				>90	34830			

Model	Version	Length (mm)	Type Power (W/PCS)	Input Voltage (V)	Input Current (mA)	CRI	Lumens (LM/PCS)	CCT	
S-CS7035P	Regular	900 [2.95ft]	96	AC200-240V	480	>80	9600	2700K 3000K 3500K 4000K 5000K 6500K	
						>90	8256		
		1200 [3.94ft]	136	AC200-240V	690	>80	13600		
						>90	11696		
		1500 [4.92ft]	156	AC200-240V	790	>80	15600		
						>90	13416		
		1800 [5.91ft]	216	AC200-240V	1090	>80	21600		
						>90	18576		
		2400 [7.87ft]	300	AC200-240V	1520	>80	30000		
						>90	25800		
		High-Efficiency	900 [2.95ft]	96	AC200-240V	480	>80		11520
							>90		9907
	1200 [3.94ft]		136	AC200-240V	690	>80	16320		
						>90	14035		
	1500 [4.92ft]		156	AC200-240V	790	>80	18720		
						>90	16099		
	1800 [5.91ft]	216	AC200-240V	1090	>80	25920			
					>90	22291			
2400 [7.87ft]	300	AC200-240V	1520	>80	36000				
				>90	30960				

Note:

1. The output data is based on white coated luminaire with Ra80,4000K.
2. The above Lumens data are at 4000K color temperature.
3. High-efficiency version does not do 3500K and 5000K
4. The tolerance of output data can be vary up to 15%.
5. The output data is typical value.
6. The following is an example of lumen conversion instructions:

CCT	RA	Ratio of lumens (white coated luminaire)	Ratio of lumens (Other coated colors of luminaire)
2700K	80	90%	Calculate white coated luminaire lumens first, then multiply by 90 %
	90	77%	
3000K	80	93%	
	90	80%	
3500K	80	97%	
	90	83%	
4000K	80	100%	
	90	86%	
5000K	80	100%	
	90	86%	
6500K	80	100%	
	90	86%	

Note: All other lumens are to be based on white coated luminaire with 4000K,RA80(100%),and multiplied by the percentage in the table above.

Assuming a 4000K, RA80 white coated luminaire with 1000lm lumens:

Example 1: If you need 4000K,RA90 lumens (white coated luminaire)	$1000 \times 86\% = 860\text{lm}$
Example 2: If you need 4000K,RA90 lumens (other coated colors of luminaire)	$1000 \times 86\% \times 90\% = 774\text{lm}$
Example 3: If you need 3000K,RA80 lumens (white coated luminaire)	$1000 \times 93\% = 930\text{lm}$
Example 4: If you need 3000K,RA90 lumens (white coated luminaire)	$1000 \times 80\% = 800\text{lm}$
Example 5: If you need 5000K,RA80 lumens (white coated luminaire)	$1000 \times 100\% = 1000\text{lm}$

© Optical Parameter

【S-CS3535D】

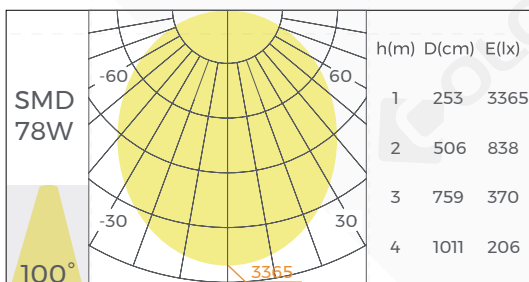

Regular version

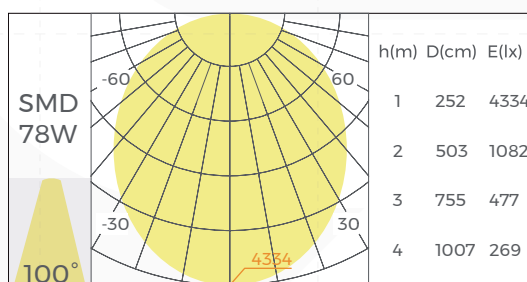

High-efficiency version

*The above data is based on a 1200mm length luminaire with Ra80,4000K.

[S-CS3535P]

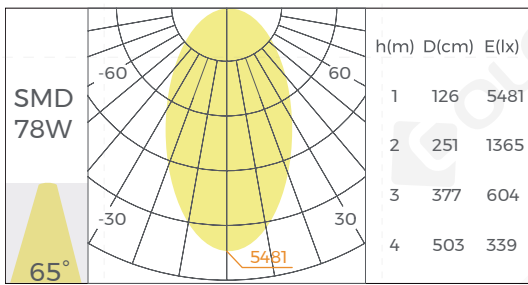

Regular version

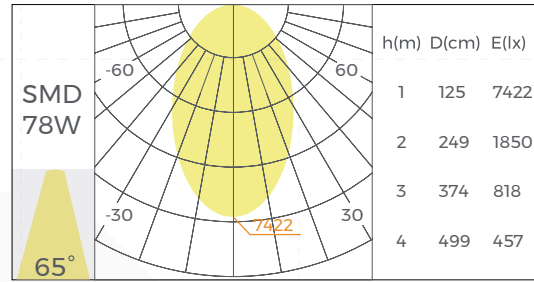

High-efficiency version

*The above data is based on a 1200mm length luminaire with Ra80,4000K.

[S-CS5035D]

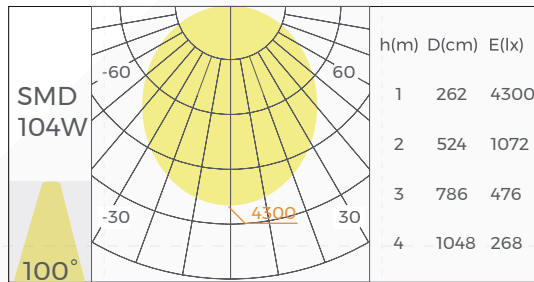

Regular version

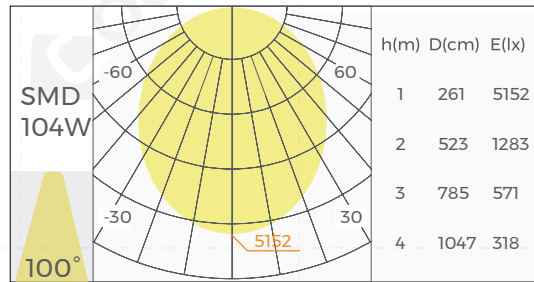

High-efficiency version

*The above data is based on a 1200mm length luminaire with Ra80,4000K.

[S-CS5035P]

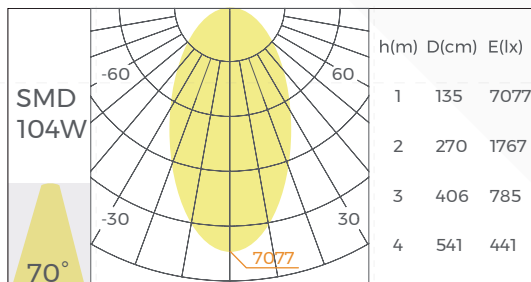

Regular version

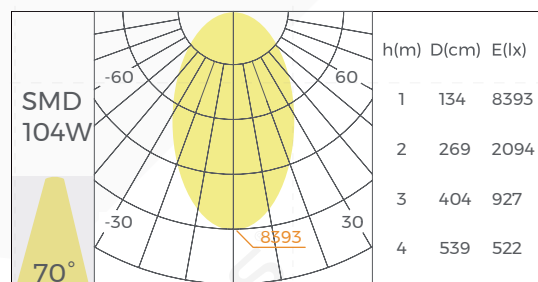

High-efficiency version

*The above data is based on a 1200mm length luminaire with Ra80,4000K.

[S-CS7035D]

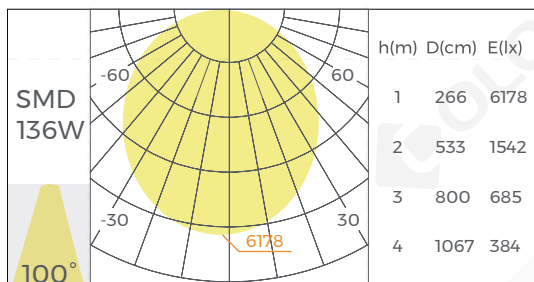

Regular version

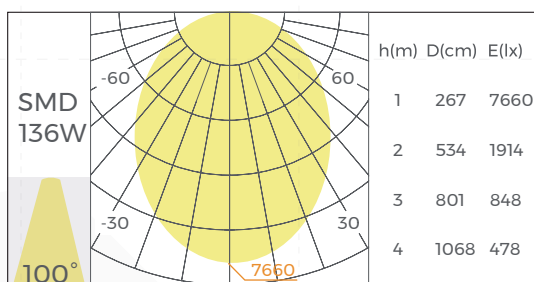

High-efficiency version

*The above data is based on a 1200mm length luminaire with Ra80,4000K.

[S-CS7035P]

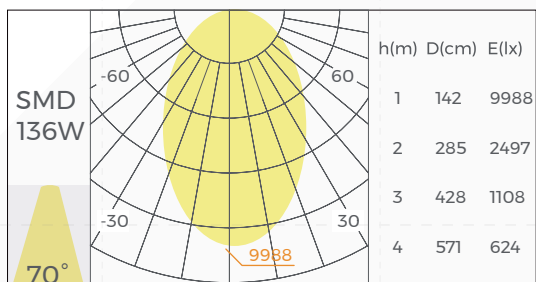

Regular version

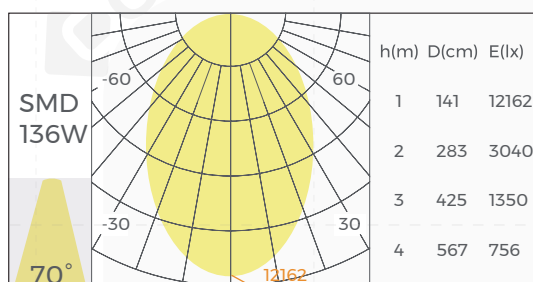

High-efficiency version

*The above data is based on a 1200mm length luminaire with Ra80,4000K.

© Installation

External power supply



Ceiling

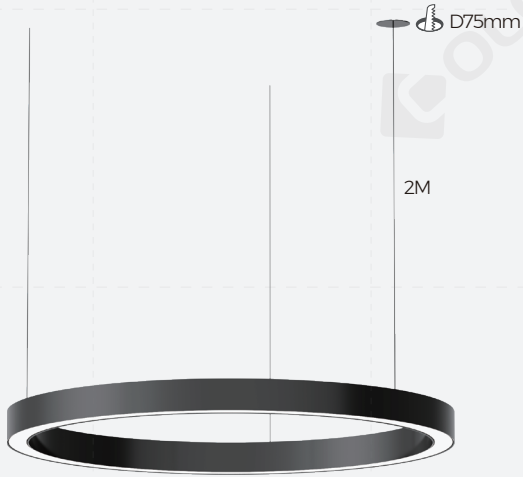
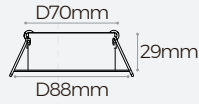

Ceiling plate
(With Steel Wire Rope)

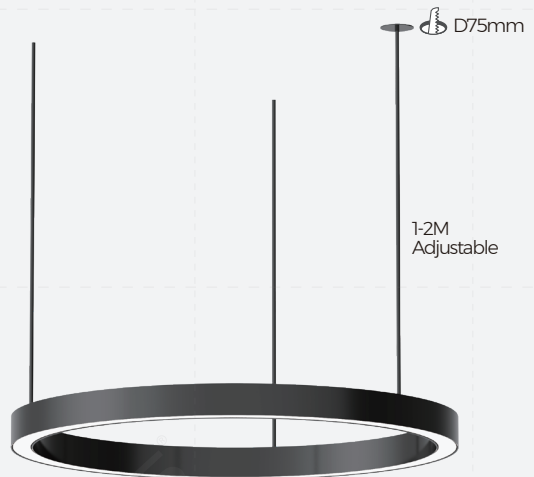
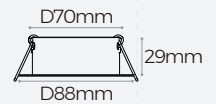

Ceiling plate
(With Rod)

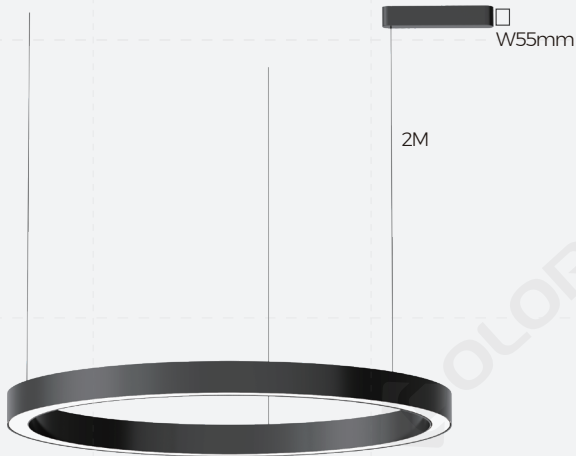

Linear Power Box
(With Steel Wire Rope)

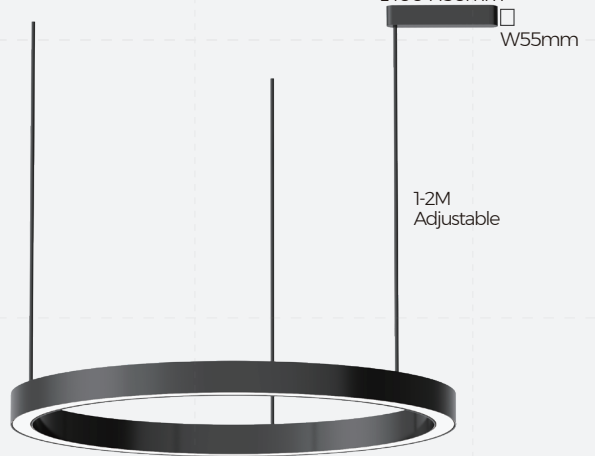

Linear Power Box
(With Rod)

- Note:
1. The above illustration shows the installation method.
 2. The above luminaire shapes are for installation illustration only.

◎Packing

Model	Quantity (PCS/carton)	NW (kg/carton)	GW (kg/carton)	Size (mm/carton)
S-CS3535D0600(R)-N840W036	4	7.40	9.80	670*670*380 [26.37"*26.37"*14.96"]
S-CS3535D0900(R)-N840W060	4	11.00	14.20	970*970*380 [38.18"*38.18"*14.96"]
S-CS3535D1200(R)-N840W078	4	14.60	18.60	1270*1270*380 [50"*50"*14.96"]
S-CS3535D1500(R)-N840W108	2	9.10	11.10	820*820*320 [32.28"*32.28"*12.59"]
S-CS3535D1800(R)-N840W128	2	10.90	13.70	970*970*320 [38.18"*38.18"*12.59"]
S-CS3535D2400(R)-N840W156	2	14.50	17.70	1270*1270*320 [50"*50"*12.59"]
S-CS5035D0600(R)-N840W044	4	9.20	11.60	670*670*380 [26.37"*26.37"*14.96"]
S-CS5035D0900(R)-N840W075	4	13.72	16.92	970*970*380 [38.18"*38.18"*14.96"]
S-CS5035D1200(R)-N840W104	4	18.24	22.24	1270*1270*380 [50"*50"*14.96"]
S-CS5035D1500(R)-N840W135	2	11.50	13.90	820*820*320 [32.28"*32.28"*12.59"]
S-CS5035D1800(R)-N840W156	2	13.70	16.50	970*970*320 [38.18"*38.18"*12.59"]
S-CS5035D2400(R)-N840W224	2	18.40	21.60	1270*1270*320 [50"*50"*12.59"]
S-CS7035D0900(R)-N840W096	4	16.36	19.56	970*970*380 [38.18"*38.18"*14.96"]
S-CS7035D1200(R)-N840W136	4	21.68	25.68	1270*1270*380 [50"*50"*14.96"]
S-CS7035D1500(R)-N840W156	2	13.70	16.10	820*820*320 [32.28"*32.28"*12.59"]

Model	Quantity (PCS/carton)	NW (kg/carton)	GW (kg/carton)	Size (mm/carton)
S-CS7035D1800(R)-N840W216	2	16.40	19.20	970*970*320 [38.18"*38.18"*12.59"]
S-CS7035D2400(R)-N840W300	2	21.60	24.80	1270*1270*320 [50"*50"*12.59"]

- Note:
- Lamps packaged without inner box, directly use the outer box.
 - Use one outer box for each lamp, and then use the wrap and corner protectors to tie them together according to the quantity of carton above.
 - The above weight data is for reference, the exact data should be based on the weight of the physical weighing shall prevail.

Model Code

S	-	C		S		3535		D		1200		(R)	-	N		8		40		B	-	078
Series A: Arc series C: Circle series S: Square series W: Wave series T: Triangle series H: Hexagon series D: Diamond series		Type R: Right angle C: Curve angle		Installation E: Recessed S: Ceiling/Pendant		Size 3535: Luminous surface width 35mm: Lamp height		Optical Type D: Diffuser P: Prismatic		Length 1200: 1200mm		Version (R): Regular (H): High-efficiency		Dimming Method N: Non-dimming D: 1-10V A: DALI		CRI 8: Ra>80 9: Ra>90		CCT 27: 2700K 30: 3000K 40: 4000K		Color B: Black W: White S: Silver		Type power 078: 75W

Attentions

- Non-professionals are prohibited from installing, disassembling and repairing the product.
- Avoid scratching, distortion and irregular bending of the product during installation; otherwise it may cause irreparable damage to the product.
- Please use professional cutting tools when cutting
- Do not use any acid or alkaline adhesive to fix products
- The product is only suitable for indoor dry places, can not be used in outdoor, seaside or wet environment.
- PC features: Each 10°C rise or drop will make diffuser extend or shrink 0.8mm/m, please confirm before processing and use